



GEBRUIKERSHANDLEIDING



MANUEL D'UTILISATION



USER MANUAL



BEDIENUNGSANLEITUNG







Copyright

This publication, including all photographs, and illustrations, is protected under international copyright laws, with all rights reserved. Neither this manual, nor any of the material contained herein, may be reproduced without written consent of the author. © Copyright 20201

Disclaimer

The information in this document is subject to change without notice. The manufacturer makes no representations or warranties with respect to the contents hereof and specifically disclaims any implied warranties of merchantability or fitness for any particular purpose. The manufacturer reserves the right to revise this publication and to make changes from time to time in the content hereof without obligation of the manufacturer to notify any person of such revision or changes.

	GEBRUIKERSHANDLEIDING	4
	MANUEL D'UTILISATION	15
	USER MANUAL	26
	BEDIENUNGSANLEITUNG	37



Gebruikershandleiding elektronisch slot

1. Algemeen

1.1 Code invoer

Het elektronische slot werkt met een 6-tot 8-cijferige code. Iedere invoer wordt bevestigd door een piepsignaal en het oplichten van het groene lampje.

Na het intoetsen van een geldige code volgt er twee keer een kort signaal en knippert het groene lampje twee keer. Bij een ongeldige code krijgt u een lang signaal en knippert het rode lampje.

1.2 Kluis openen

Als u de kluis voor het eerst opent, gebruik dan de fabriekscode (ON - fabriekscode 123456 - ENTER).

U kunt de kluis openen met de mastercode en met een gebruikerscode.

Na het invoeren van de code dient u de deur binnen vijf seconden te ontgrendelen door middel van de handgreep. Opent u het slot niet binnen vijf seconden dan wordt het slot automatisch weer vergrendeld.

1.3 Kluis sluiten

Sluit de deur en draai de handgreep in sluit-positie. Het slot wordt nu automatisch vergrendeld. U kunt testen of het slot is vergrendeld door de handgreep in de open-positie te draaien.

1.4 Blokkering

Het toetsenbord wordt automatisch vijf minuten geblokkeerd indien er drie foutieve codes achter elkaar worden ingevoerd. Gedurende deze periode knippert het rode lampje elke paar seconden. Wanneer u na afloop van de blokkeerperiode weer twee keer een foutieve code ingeeft, volgt er opnieuw een wachttijd van vijf minuten.

1.5 Veiligheidsadvies

Zet bij het in gebruik nemen van de kluis direct de standaard fabriekscode om in uw eigen persoonlijke toegangscode. Wanneer u een code kiest, vermijd dan voor de hand liggende combinaties zoals de getallen van uw geboortedatum of een deel van uw telefoonnummer of postcode. Onthoud de code en houd deze voor uzelf. Wilt u de code toch graag opschrijven, bewaar deze dan op een veilige plek.

Symbolen	Betekenis
	Groen lampje brandt
	Geluidssignaal
	Rood lampje brandt























Gebruikershandleiding elektronisch slot

2. Master- en gebruikerscodes

2.1 Mastercode wijzigen

Zorg ervoor dat de kluisdeur geopend is als u de code gaat wijzigen. Toets ON - mastercode - ENTER (of fabriekscod 123456 wanneer u het slot voor de eerste keer gebruikt).

Stap	Betekenis	Toets	Signaal
1.	Toets ON	ON	 
2.	Toets Enter	Enter	 
3.	Toets 1	1	 
4.	Toets Enter	Enter	 
5.	Toets mastercode (of fabriekscod 123456 bij eerste gebruik)	123456	 
6.	Toets Enter	Enter	 
7.	Toets nieuwe mastercode, bijvoorbeeld 567891	567891	 
8.	Toets Enter	Enter	 
9.	Herhaal nieuwe mastercode, bijvoorbeeld 567891	567891	 
10.	Toets Enter	Enter	 

De nieuwe mastercode staat nu ingesteld. Indien de nieuwe code niet wordt geaccepteerd, klinkt er een lang signaal en knippert er een rood lampje. Begin dan opnieuw bij stap 1 om de mastercode te wijzigen. Na het wijzigen van de code kunt u het beste de nieuwe code meermaals testen bij een geopende deur.



























Gebruikershandleiding elektronisch slot

2.2 Gebruikerscode instellen

De gebruikerscode kan alleen ingesteld worden als de mastercode gewijzigd is van de fabriekscodes naar uw gepersonaliseerde code. Let op, de gebruikerscode mag niet hetzelfde zijn als de mastercode!

Zorg ervoor dat de kluisdeur geopend is als u de code gaat wijzigen (ON – mastercode – ENTER).

Er kunnen 9 gebruikers worden aangemaakt. Elke gebruiker krijgt een ID-nummer. Bijvoorbeeld gebruiker 1 krijgt ID-nummer "1".

Stap	Betekenis	Toets	Signaal
1.	Toets ON	ON	 
2.	Toets Enter	Enter	 
3.	Toets 2	2	 
4.	Toets Enter	Enter	 
5.	Toets ID-nummer (kies uit 1-9), bijvoorbeeld 1	1	 
6.	Toets Enter	Enter	 
7.	Toets mastercode, bijvoorbeeld 567891	567891	 
8.	Toets Enter	Enter	 
9.	Toets nieuwe gebruikerscode, bijvoorbeeld 111111	111111	 
10.	Toets Enter	Enter	 
11.	Herhaal nieuwe gebruikerscode, bijvoorbeeld 111111	111111	 
12.	Toets Enter	Enter	 

De nieuwe gebruikerscode staat nu ingesteld. Indien de nieuwe code niet wordt geaccepteerd, klinkt er een lang signaal en knippert er een rood lampje. Begin dan opnieuw bij stap 1 om de gebruikerscode in te stellen.

Na het instellen van de code kunt u het beste de nieuwe code meermaals testen bij een geopende deur.































Gebruikershandleiding elektronisch slot

2.3 Gebruikerscode wijzigen (door gebruiker, zonder mastercode)

Let op, de gebruikerscode mag niet hetzelfde zijn als de mastercode!

Zorg ervoor dat de kluisdeur geopend is als u de code gaat wijzigen (ON – gebruikerscode – ENTER).

Er kunnen 9 gebruikers worden aangemaakt. Elke gebruiker krijgt een ID-nummer. Bijvoorbeeld gebruiker 1 krijgt ID-nummer "1".

Stap	Betekenis	Toets	Signaal
1.	Toets ON	ON	 
2.	Toets Enter	Enter	 
3.	Toets 3	3	 
4.	Toets Enter	Enter	 
5.	Toets ID-nummer (kies uit 1-9), bijvoorbeeld 1	1	 
6.	Toets Enter	Enter	 
7.	Toets gebruikerscode, bijvoorbeeld 111111	111111	 
8.	Toets Enter	Enter	   
9.	Toets nieuwe gebruikerscode, bijvoorbeeld 222222	222222	 
10.	Toets Enter	Enter	   
11.	Herhaal nieuwe gebruikerscode, bijvoorbeeld 222222	222222	 
12.	Toets Enter	Enter	   

De nieuwe gebruikerscode staat nu ingesteld. Indien de nieuwe code niet wordt geaccepteerd, klinkt er een lang signaal en knippert er een rood lampje. Begin dan opnieuw bij stap 1 om de gebruikerscode te wijzigen.



















Na het wijzigen van de code kunt u het beste de nieuwe code meermaals testen bij een geopende deur.



Gebruikershandleiding elektronisch slot

2.4 Gebruikerscode verwijderen

Alleen met de mastercode kunt u een gebruikerscode verwijderen.

Stap	Betekenis	Toets	Signaal
1.	Toets ON	ON	 
2.	Toets Enter	Enter	 
3.	Toets 0	0	 
4.	Toets Enter	Enter	 
5.	Toets ID-nummer (kies uit 1-9), bijvoorbeeld 1	1	 
6.	Toets Enter	Enter	 
7.	Toets mastercode, bijvoorbeeld 567891	567891	 
8.	Toets Enter	Enter	   

De gebruikerscode is verwijderd. Alleen de mastercode is nog geldig. Indien het verwijderen van de gebruiker niet is gelukt, klinkt er een lang signaal en knippert er een rood lampje. Begin dan opnieuw bij stap 1 om de gebruikerscode te verwijderen.



Gebruikershandleiding elektronisch slot

3. Openingsvertraging en openingsvenster

Openingsvertraging 1-99 minuten:

De wachttijd voordat u het slot kan openen.

Openingsvenster 1-9 minuten:



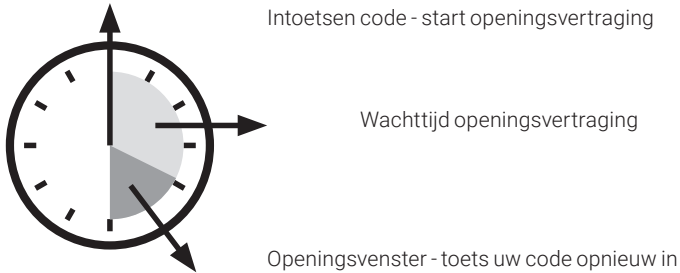



In dit venster dient u opnieuw de code in te voeren voor het openen van de kluis.



3.1 Inschakelen openingsvertraging en openingsvenster

Alleen de mastercode kan een openingsvertraging en openingsvenster programmeren.

Zorg ervoor dat de kluisdeur geopend is als u een openingsvertraging en openingsvenster gaat programmeren (ON – mastercode – ENTER).

Stap	Betekenis	Toets	Signaal
1.	Toets ON	ON	 
2.	Toets Enter	Enter	 
3.	Toets 6	6	 
4.	Toets Enter	Enter	 
5.	Toets mastercode, bijvoorbeeld 567891	567891	 
6.	Toets Enter	Enter	   
7.	Toets openingsvertraging met 2 cijfers, bijvoorbeeld 5 minuten	05	 
8.	Toets openingsvenstertijd met 1 cijfer, bijvoorbeeld 1 minuut	1	 
9.	Toets Enter	Enter	   

De openingsvertraging en het openingsvenster staan nu ingesteld.



Gebruikershandleiding elektronisch slot

3.2 Openen met openingsvertraging en openingsvenster

Stap	Betekenis	Toets	Signaal
1.	Toets ON	ON	 
2.	Toets gebruikers- of mastercode, bijvoorbeeld 567891	567891	 
3.	Toets Enter	Enter	 
4.	Openingsvertragingstijd start, het rode lampje brandt elke 5 seconden		
5.	Openingsvertragingstijd is verstreken, u hoort een geluidssignaal		
6.	Openingsvenstertijd start, u hoort een geluidssignaal en het rode lampje brandt elke 5 seconden		 
7.	Toets gebruikers- of mastercode, bijvoorbeeld 567891	567891	 
8.	Toets Enter	Enter	   
9.	Open de handgreep binnen 5 seconden, de kluis is geopend.		

3.3 Openingsvertraging deactiveren

Open het slot, volg daarvoor de stappen bij 3.2.

Stap	Betekenis	Toets	Signaal
1.	Toets ON	ON	 
2.	Toets Enter	Enter	 
3.	Toets 6	6	 
4.	Toets Enter	Enter	 
5.	Toets mastercode, bijvoorbeeld 567891	567891	 
6.	Toets Enter	Enter	   
7.	Toets 000	000	
8.	Toets Enter	Enter	   

De openingsvertraging en het openingsvenster zijn nu gedeactiveerd.

















Gebruikershandleiding elektronisch slot

3.4 Openingsvertraging en/of openingsvenster wijzigen

Deactiveer eerst de eerder ingestelde openingsvertraging en het openingsvenster (zie 3.3).
Volg daarna de stappen bij 3.2 om een nieuwe openingsvertraging en openingsvenster in te stellen.

3.5 Geluidssignaal openingsvenster aan- of uitzetten

Alleen met de mastercode kunt u het geluidssignaal aan- of uitzetten.

Stap	Betekenis	Toets	Signaal
1.	Toets ON	ON	 
2.	Toets Enter	Enter	 
3.	Toets 5	5	 
4.	Toets Enter	Enter	 
5.	Toets mastercode, bijvoorbeeld 567891	567891	 
6.	Toets Enter	Enter	   















Gebruikershandleiding elektronisch slot

4. Dubbele code (4-ogen-principe)

4.1 Inschakelen dubbele code

Zorg ervoor dat u minimaal één gebruikerscode heeft aangemaakt (zie 2.2).











Zorg ervoor dat de kluisdeur geopend is als u de dubbele code gaat inschakelen (ON - mastercode - ENTER).

Stap	Betekenis	Toets	Signaal
1.	Toets ON	ON	 
2.	Toets Enter	Enter	 
3.	Toets 7	7	 
4.	Toets Enter	Enter	 
5.	Toets mastercode, bijvoorbeeld 567891	567891	 
6.	Toets Enter	Enter	 

De functie dubbele code staat ingeschakeld.

4.2 Openen met dubbele code

Het slot kan nu geopend worden met de mastercode (ID-nummer 0) en de gebruikerscodes die u heeft geprogrammeerd.







Stap	Betekenis	Toets	Signaal
1.	Toets ON	ON	 
2.	Toets ID-nummer, bijvoorbeeld 1	1	 
3.	Toets Enter	Enter	 
4.	Toets gebruikerscode van ID-nummer 1, bijvoorbeeld 111111	111111	 
5.	Toets Enter	Enter	 
6.	Toets ID-nummer, bijvoorbeeld 2	2	 
7.	Toets Enter	Enter	 
8.	Toets binnen 1 minuut gebruikerscode van ID-nummer 2, bijvoorbeeld 222222	222222	 
9.	Toets Enter	Enter	 

Open de handgreep binnen 5 seconden, de kluis is geopend.



Gebbruikershandleiding elektronisch slot

4.3 Dubbele code deactiveren

Stap	Betekenis	Toets	Signaal
1.	Toets ON	ON	
2.	Toets Enter	Enter	
3.	Toets 8	8	
4.	Toets Enter	Enter	
5.	Toets mastercode, bijvoorbeeld 567891	567891	
6.	Toets Enter	Enter	

De dubbele code is nu uitgeschakeld.



Gebruikershandleiding elektronisch slot

5. Stroomvoorziening

5.1 Batterij wisselen

Zodra de batterij bijna leeg is (en de spanning te laag wordt), zal het rode lampje 5 keer gaan knipperen en klinkt er bij het openen van de deur meermaals een waarschuwingssignaal. Dit is het teken dat de batterij moet worden verwisseld.

Gebruik geen oplaadbare batterijen, maar alleen 9V batterijen van hoge kwaliteit.

Schroef het batterijklepje aan de binnenkant van de deur los. Neem de batterij uit, plaats een nieuwe batterij en schroef vervolgens het klepje weer vast. Test vervolgens het openen en sluiten een paar keer met geopende deur.

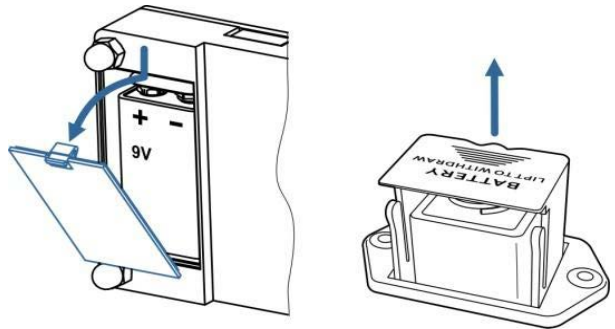

5.2 Noodstroomvoorziening

Op het toetsenbord bevindt zich de noodstroomvoorziening voor het geval de geplaatste batterij geheel leeg is geraakt. Verwijder het plastic afdekplaatje met een schroevendraaier. Houd een nieuwe 9V blokbatterij goed tegen de '+' en volg de normale openingsprocedure om de kluis te openen. Hierna kunt de lege batterij vervangen.

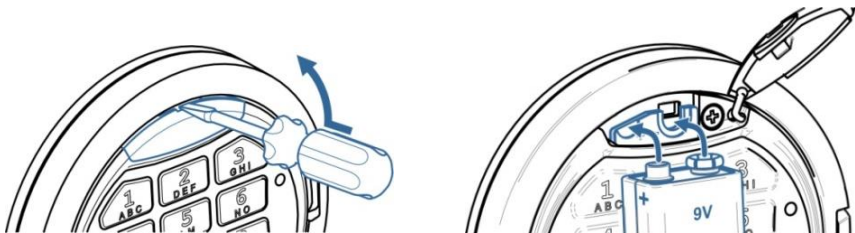

Heeft u vragen over uw kluis, het elektronische slot of is er onverhoopt een storing opgetreden? Neem dan contact met ons op.



Manuel d'utilisation Serrure électronique

1. Général

1.1 Saisie du code

La serrure électronique fonctionne avec un code de 6 à 8 chiffres. Chaque saisie est confirmée par un signal acoustique et par un clignotement du voyant vert.

Après avoir composé un code correcte, un double signal suit et le voyant vert clignote deux fois. Si vous avez saisi un code erroné, vous aurez un signal long et le voyant rouge clignote.

1.2 Ouverture du coffre-fort

A la première ouverture du coffre, utilisez le code usine (ON - code usine 123456 - ENTER).

Vous pouvez ouvrir le coffre avec le code master et avec un code utilisateur.

Après la saisie du code, tournez la poignée de votre coffre dans les cinq secondes qui suivent, sinon la serrure se bloque automatiquement.

1.3 Fermeture du coffre-fort



Fermez la porte et tournez la poignée du coffre dans le sens de la fermeture. La serrure se bloque automatiquement. Vérifiez la bonne fermeture de votre coffre en tournant la poignée dans le sens de l'ouverture.

1.4 Protection contre la manipulation

Si vous composez trois codes erronés successivement, la serrure se bloquera automatiquement pendant cinq minutes. Pendant cette période, le voyant rouge clignotera toutes les deux secondes. Si après la période de blocage vous ressaisissez un mauvais code, la serrure se bloquera de nouveau pendant cinq minutes.

1.5 Recommandations importantes

Avant d'utiliser le coffre-fort changez immédiatement le code usine en votre code personnel. N'utilisez jamais un code constitué de données personnelles, telles que dates de naissance, numéro de téléphone etc. Retenez bien le code composé et ne le communiquez à personne. Si vous souhaitez toutefois noter le code, gardez-le en lieu sûr.

Symboles	Signification
	voyant vert est allumé
	signal acoustique
	voyant rouge est allumé





























Manuel d'utilisation Serrure électronique

2. Code master et code utilisateurs

2.1 Changement du code master

Il est à conseiller de changer le code avec la porte ouverte. Pour ouvrir la porte, saisissez ON - code master - ENTER (ou code usine si vous utilisez la serrure pour la première fois).

Etape	Action	Saisissez	Signal
1.	Saisissez ON	ON	 
2.	Saisissez Enter	Enter	 
3.	Saisissez 1	1	 
4.	Saisissez Enter	Enter	 
5.	Composez le code master (ou code usine 123456 lors de la première utilisation)	123456	 
6.	Saisissez Enter	Enter	   
7.	Composez le nouveau code master, par exemple 567891	567891	 
8.	Saisissez Enter	Enter	   
9.	Répétez le nouveau code master, par exemple 567891	567891	 
10.	Saisissez Enter	Enter	   

Le nouveau code master a été programmé. Si le nouveau code n'est pas accepté, vous entendez un long signal et le voyant rouge clignote. Dans ce cas, recommencez à étape 1 pour changer le code master. Il est à conseiller de tester le nouveau code plusieurs fois avec la porte ouverte.



Manuel d'utilisation Serrure électronique

2.2 Programmation ou changement du code utilisateur (par code master)

Changez d'abord le code master du code usine en votre code personnel, sinon vous ne pouvez pas programmer le code utilisateur. Attention, le code utilisateur doit être différent du code master. Il est à conseiller de programmer ou changer le code utilisateur avec la porte ouverte. Pour ouvrir la porte, saisissez ON – code master – ENTER.

Vous pouvez programmer 9 utilisateurs. Chaque utilisateur a un code ID. Par exemple, le premier utilisateur a le code ID "1".

Etape	Action	Saisissez	Signal
1.	Saisissez ON	ON	 
2.	Saisissez Enter	Enter	 
3.	Saisissez 2	2	 
4.	Saisissez Enter	Enter	 
5.	Saisissez code ID (choisissez parmi 1-9), par exemple 1	1	 
6.	Saisissez Enter	Enter	 
7.	Composez le code master, par exemple 567891	567891	 
8.	Saisissez Enter	Enter	   
9.	Composez le nouveau code utilisateur, par exemple 111111	111111	 
10.	Saisissez Enter	Enter	   
11.	Répétez le nouveau code utilisateur, par exemple 111111	111111	 
12.	Saisissez Enter	Enter	   

Le code utilisateur a été programmé. Si ce code n'est pas accepté, vous entendez un long signal et le voyant rouge clignote. Dans ce cas, recommencez à étape 1 pour changer le code utilisateur. Il est à conseiller de tester le nouveau code plusieurs fois avec la porte ouverte.



Manuel d'utilisation Serrure électronique

2.3 Changement code utilisateur (par utilisateur, sans code master)

Attention, le code utilisateur doit être différent du code master ! Il est à conseiller de changer le code avec la porte ouverte. Pour ouvrir la porte, saisissez ON – code utilisateur – ENTER.

Vous pouvez programmer 9 utilisateurs. Chaque utilisateur a un code ID. Par exemple, le premier utilisateur a le code ID "1".

Etape	Action	Saisissez	Signal
1.	Saisissez ON	ON	 
2.	Saisissez Enter	Enter	 
3.	Saisissez 3	3	 
4.	Saisissez Enter	Enter	 
5.	Saisissez code ID (choisissez parmi 1-9), par exemple 1	1	 
6.	Saisissez Enter	Enter	 
7.	Composez le code utilisateur, par exemple 111111	111111	 
8.	Saisissez Enter	Enter	   
9.	Composez le nouveau code utilisateur, par exemple 222222	222222	 
10.	Saisissez Enter	Enter	   
11.	Répétez le nouveau code utilisateur, par exemple 222222	222222	 
12.	Saisissez Enter	Enter	   



















Le nouveau code utilisateur a été programmé. Si le nouveau code n'est pas accepté, vous entendez un long signal et le voyant rouge clignote. Dans ce cas, recommencez à étape 1 pour changer le code utilisateur. Il est à conseiller de tester le nouveau code plusieurs fois avec la porte ouverte.



Manuel d'utilisation Serrure électronique

2.4 Enlèvement code utilisateur

C'est seulement avec le code master que vous pouvez enlever un code utilisateur

Etape	Action	Saisissez	Signal
1.	Saisissez ON	ON	 
2.	Saisissez Enter	Enter	 
3.	Saisissez 0	0	 
4.	Saisissez Enter	Enter	 
5.	Saisissez code ID (choisissez parmi 1-9), par exemple 1	1	 
6.	Saisissez Enter	Enter	 
7.	Composez le code master, par exemple 567891	567891	 
8.	Saisissez Enter	Enter	   

Le code utilisateur a été enlevé et le code master est le seul code en vigueur. Si l'enlèvement du code n'est pas accepté, vous entendez un long signal et le voyant rouge clignote. Dans ce cas, recommencez à étape 1 pour enlever le code utilisateur.



Manuel d'utilisation Serrure électronique

3. Retardement d'ouverture et durée de temporisation

Retardement d'ouverture 1-99 minutes:

Le temps d'attente avant que vous puissiez ouvrir la serrure.

Durée de temporisation 1-9 minutes:

La durée pendant laquelle il faut saisir de nouveau votre code.

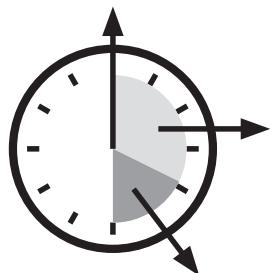























Saisie du code - début du retardement d'ouverture

Temps d'attente du retardement d'ouverture

Durée de temporisation - saisissez votre code de nouveau

3.1 Activation du retardement d'ouverture et de la durée de temporisation

C'est seulement le code master qui peut programmer un retardement d'ouverture et une durée de temporisation. Il est à conseiller de programmer avec la porte ouverte. Pour ouvrir la porte, saisissez ON – code master – ENTER.

















Etape	Action	Saisissez	Signal
1.	Saisissez ON	ON	 
2.	Saisissez Enter	Enter	 
3.	Saisissez 6	6	 
4.	Saisissez Enter	Enter	 
5.	Composez le code master, par exemple 567891	567891	 
6.	Saisissez Enter	Enter	   
7.	Saisissez le retardement d'ouverture avec 2 chiffres, par exemple 5 minutes	05	 
8.	Saisissez la durée de temporisation avec 1 chiffre, par exemple 1 minute	1	 
9.	Saisissez Enter	Enter	   

Le retardement d'ouverture et la durée de temporisation ont été programmés.





















Manuel d'utilisation Serrure électronique

3.2 Ouverture avec retardement d'ouverture et durée de temporisation

Etape	Action	Saisissez	Signal
1.	Saisissez ON	ON	 
2.	Composez le code utilisateur ou master, par exemple 567891	567891	 
3.	Saisissez Enter	Enter	 
4.	Le retardement d'ouverture commence et le voyant rouge clignote toutes les 5 secondes		
5.	Le retardement d'ouverture est passé et vous entendez un signal sonore		
6.	La durée de temporisation commence, vous entendez un signal sonore et le voyant rouge clignote toutes les 5 secondes		 
7.	Composez le code utilisateur ou master, par exemple 567891	567891	 
8.	Saisissez Enter	Enter	   
9.	Tournez la poignée dans les 5 secondes, et le coffre est ouvert		

3.3 Désactivation du retardement d'ouverture

D'abord ouvrez la serrure (suivez les étapes décrites sous chapitre 3.2.)

Etape	Action	Saisissez	Signal
1.	Saisissez ON	ON	
2.	Saisissez Enter	Enter	 
3.	Saisissez 6	6	 
4.	Saisissez Enter	Enter	 
5.	Composez le code master, par exemple 567891	567891	 
6.	Saisissez Enter	Enter	 
7.	Saisissez 000	000	   
8.	Saisissez Enter	Enter	   

Le retardement d'ouverture et la durée de temporisation sont maintenant désactivés.

















Manuel d'utilisation Serrure électronique

3.4 Changement du retardement d'ouverture et de la durée de temporisation

D'abord désactivez le retardement d'ouverture programmé (suivez les étapes décrites sous chapitre 3.3). Ensuite suivez les étapes sous 3.2 pour programmer un nouveau retardement d'ouverture et une nouvelle durée de temporisation.

3.5 Activation / désactivation du signal acoustique

C'est seulement le code master qui peut activer ou désactiver le signal acoustique.

Etape	Action	Saisissez	Signal
1.	Saisissez ON	ON	 
2.	Saisissez Enter	Enter	 
3.	Saisissez 5	5	 
4.	Saisissez Enter	Enter	 
5.	Composez le code master, par exemple 567891	567891	 
6.	Saisissez Enter	Enter	   















Manuel d'utilisation Serrure électronique

4. Double code (principe des 4 yeux)

4.1 Activation double code

D'abord programmez au minimum un code utilisateur (voir 2.2).



















Il est à conseiller de programmer le double code avec la porte ouverte. Pour ouvrir la porte, saisissez ON - code master - ENTER.

Etape	Action	Saisissez	Signal
1.	Saisissez ON	ON	 
2.	Saisissez Enter	Enter	 
3.	Saisissez 7	7	 
4.	Saisissez Enter	Enter	 
5.	Saisissez le code master, par exemple 567891	567891	 
6.	Saisissez Enter	Enter	 

La fonction double code a maintenant été activée.

4.2 Ouverture avec double code

La serrure peut maintenant être ouverte avec le code master (code ID 0) et les codes utilisateurs que vous avez programmés.

Etape	Action	Saisissez	Signal
1.	Saisissez ON	ON	 
2.	Saisissez le code ID, par exemple 1	1	 
3.	Saisissez Enter	Enter	 
4.	Composez le code utilisateur du code ID 1, par exemple 111111	111111	 
5.	Saisissez Enter	Enter	 
6.	Saisissez le code ID, par exemple 2	2	 
7.	Saisissez Enter	Enter	 
8.	Dans un délai de 1 minute, composez le code utilisateur du code ID 2, par exemple 222222	222222	 
9.	Saisissez Enter	Enter	 

Tournez la poignée dans les 5 secondes, et le coffre est ouvert.



Manuel d'utilisation Serrure électronique

4.3 Désactivation du double code

Etape	Action	Saisissez	Signal
1.	Saisissez ON	ON	
2.	Saisissez Enter	Enter	
3.	Saisissez 8	8	
4.	Saisissez Enter	Enter	
5.	Composez le code master, par exemple 567891	567891	
6.	Saisissez Enter	Enter	

La fonction double code a maintenant été désactivée.



Manuel d'utilisation Serrure électronique

5. Alimentation

5.1 Changer la pile

Dès que la pile est épuisée (et la tension devient trop faible), le voyant rouge clignotera 5 fois et vous entendrez un signal acoustique lors de l'ouverture de la porte. Il est à conseiller de changer la pile.

N'utilisez pas de piles rechargeables, mais uniquement des piles 9V de haute qualité.

Le compartiment de pile se trouve à l'intérieur de la porte. Dévissez le couvercle du compartiment de pile et remplacez la pile par une nouvelle. Ensuite revissez le couvercle.

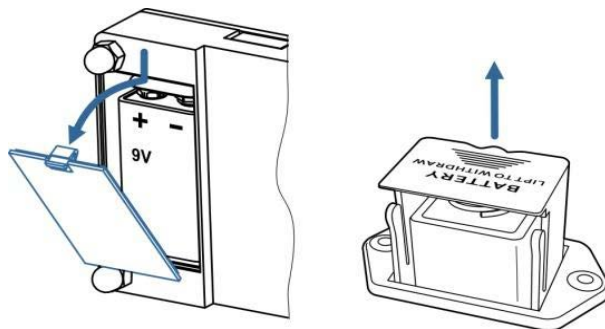

5.2 Alimentation de secours

Sur le clavier vous voyez une alimentation de secours qui vous permettra d'ouvrir la serrure dans le cas où la pile a été complètement épuisée. Enlevez la couverture en plastique avec un tournevis. Connectez une pile de 9V sur les points « - » et « + ». Ensuite suivez la procédure pour ouvrir la serrure. Changez la pile directement après l'ouverture du coffre.

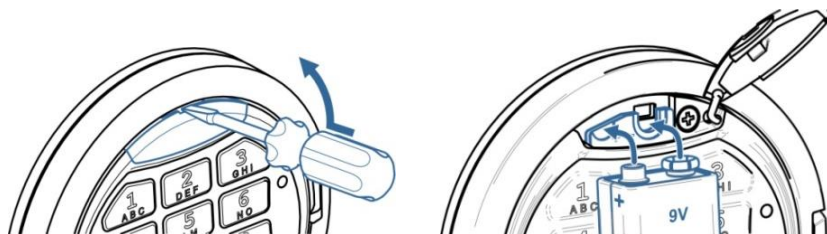

Avez-vous des questions à propos de votre coffre-fort ou de la serrure électronique, ou y-a-t-il un dysfonctionnement imprévu? Veuillez nous contacter.



User manual electronic lock

1. General

1.1 Code entry

The electronic lock works with a 6 to 8 digit code. Each input is confirmed by a beep and the green light illuminates.

After entering a valid code, you hear two short signals and the green light flashes twice. If the code is invalid, you will hear a long signal and the red light will flash.

1.2 Opening the safe

If you use the safe for the first time, open the lock with the factory code (ON - factory code 123456 - ENTER).

The lock operates with a master code and a user code.

After entering the code unlock the door within five seconds using the handle. If you do not open the lock within five seconds, the lock closes again automatically.

1.3 Closing and locking safe door



Close the door and turn handle fully to closing position. The lock is secured. You can test whether the lock is locked by turning the handle to the open position.

1.4 Blocking

If incorrect codes are entered three times in a row, the keypad blocks automatically for five minutes. The red light flashes every few seconds during that period. Entering a wrong code twice after the blocking period will start a new delay time of five minutes.

1.5 Safety reference

Once you start using the safe, change the standard factory code into your own personal access code immediately. When choosing a code, avoid obvious combinations such as numbers related to your birth date, part of your telephone number or postcode. Remember the code and keep it to yourself. If you feel the need to write it down, keep it in a safe place.

Symbols	Meaning
	Green light is on
	Sound signal
	Red light is on





























User manual electronic lock

2. Master and user code

2.1 Setting the master code

Make sure that the safe door is open when you change the code. To open the safe press ON, key in the master code (or factory code 123456 if you use the lock for the first time) and press ENTER.

Step	Action	Key	Signal
1.	Press ON	ON	 
2.	Press Enter	Enter	 
3.	Press 1	1	 
4.	Press Enter	Enter	 
5.	Key in the master code (or factory code, 123456 if you use the lock for the first time)	123456	 
6.	Press Enter	Enter	   
7.	Key in the new master code, e.g. 567891	567891	 
8.	Press Enter	Enter	   
9.	Repeat the new master code, e.g. 567891	567891	 
10.	Press Enter	Enter	   

The new master code is now set. If the new code is not accepted, you hear a long signal and a red light flashes. In that case, start again at step 1 for changing the master code. After changing the code, it is best to test the new code several times with the door open.

































User manual electronic lock

2.2 Setting the user code

You can only set a user code after changing the master code from the factory code to your personalized one. Please note – the user code may not be the same as the master code!
 Make sure that the safe door is open when you change the code (ON – master code – ENTER).

Up to 9 users can be programmed. They receive an user ID. For example, user 1 receives user ID "1".

Step	Action	Key	Signal
1.	Press ON	ON	 
2.	Press Enter	Enter	 
3.	Press 2	2	 
4.	Press Enter	Enter	 
5.	Key in a user ID (choose between 1-9), e.g. 1	1	 
6.	Press Enter	Enter	 
7.	Key in the master code, e.g. 567891	567891	 
8.	Press Enter	Enter	   
9.	Key in the new user code, e.g. 111111	111111	 
10.	Press Enter	Enter	   
11.	Repeat the new user code, e.g. 111111	111111	 
12.	Press Enter	Enter	   

The new user code is now set. If the new code is not accepted, you hear a long signal and a red light flashes. In that case, start again at step 1 for setting the user code. After setting the code, it is best to test the new code several times with the door open.

































User manual electronic lock

2.3 Changing the user code (by a user, without the master code.)

Please note – the user code may not be the same as the master code!

Make sure that the safe door is open when you change the code (ON – user code – ENTER).

Up to 9 users can be programmed. They receive an user ID. For example, user 1 receives user ID "1".

Step	Action	Key	Signal
1.	Press ON	ON	 
2.	Press Enter	Enter	 
3.	Press 3	3	 
4.	Press Enter	Enter	 
5.	Key in a user ID (choose between 1-9), e.g. 1	1	 
6.	Press Enter	Enter	 
7.	Key in the current user code, e.g. 111111	111111	 
8.	Press Enter	Enter	   
9.	Key in the new user code, e.g. 222222	222222	 
10.	Press Enter	Enter	   
11.	Repeat the new code, e.g. 222222	222222	 
12.	Press Enter	Enter	   



















The new user code is now set. If the new code is not accepted, you hear a long signal and a red light flashes. In that case, start again at step 1 for changing the user code. After changing the code, it is best to test the new code several times with the door open.



User manual electronic lock

2.4 Deleting the user code

Only the master code can delete a user code.

Step	Action	Key	Signal
1.	Press ON	ON	 
2.	Press Enter	Enter	 
3.	Press 0	0	 
4.	Press Enter	Enter	 
5.	Key in a user ID (choose between 1-9), e.g. 1	1	 
6.	Press Enter	Enter	 
7.	Key in the master code, e.g. 567891	567891	 
8.	Press Enter	Enter	   

Only the master code remains valid. If the user code deletion is unsuccessful, you hear a long signal and a red light flashes. In that case, start again at step 1 for deleting the user code.



User manual electronic lock

3. Opening delay and opening window

Opening delay 1-99 minutes:

The waiting time before you can open the lock.

Opening window 1-9 minutes:



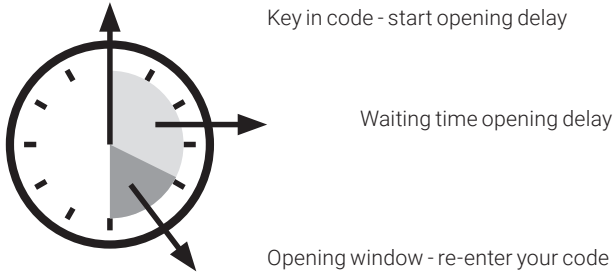



















You have to enter the code again to open the safe during this window (the period in which you can open it)



3.1 Programming opening delay and opening window

You can only program an opening delay and window by using the master code.

Make sure that the safe door is open when you start programming an opening delay and window (ON – master code – ENTER)

















Step	Action	Key	Signal
1.	Press ON	ON	 
2.	Press Enter	Enter	 
3.	Press 6	6	 
4.	Press Enter	Enter	 
5.	Key in the master code, e.g. 567891	567891	 
6.	Press Enter	Enter	   
7.	Enter the opening delay using two digits, e.g. 5 minutes	05	 
8.	Enter the opening window using single digit, e.g. 1 minute	1	 
9.	Press Enter	Enter	   

The opening delay and the opening window are now set.





















User manual electronic lock

3.2 Opening with opening delay and opening window

Step	Action	Key	Signal
1.	Press ON	ON	 
2.	Key in the user or master code, e.g. 567891	567891	 
3.	Press Enter	Enter	 
4.	The opening delay time starts, the red light illuminates every 5 seconds		
5.	The opening delay time has elapsed, you hear an audible alarm		
6.	The opening window period starts, you hear an audible signal and the red lamp illuminates every 5 seconds		 
7.	Key in the user or master code, e.g. 567891	567891	 
8.	Press Enter	Enter	   
9.	Open the handle within 5 seconds, the safe is open.		

3.3 Deactivating opening delay

Open the lock, following the steps described in 3.2.

Step	Action	Key	Signal
1.	Press ON	ON	 
2.	Press Enter	Enter	 
3.	Press 6	6	 
4.	Press Enter	Enter	 
5.	Key in the master code, e.g. 567891	567891	 
6.	Press Enter	Enter	   
7.	Press 000	000	
8.	Press Enter	Enter	   

The opening delay and the opening window are now deactivated.



User manual electronic lock

3.4 Changing the opening delay and/or opening window

Firstly, deactivate the pre-set opening delay and window (see 3.3).
Then follow the steps in 3.2 to set new opening delay and window times.

3.5 Switching the audible opening window signal off or on

You can only switch the audible signal on or off with the master code.

Step	Action	Key	Signal
1.	Press ON	ON	
2.	Press Enter	Enter	
3.	Press 5	5	
4.	Press Enter	Enter	
5.	Key in the master code, e.g. 567891	567891	
6.	Press Enter	Enter	















User manual electronic lock

4. Dual code (4 eyes principle)

4.1 Programming dual code



















Make sure you programmed at least one user code (see 2.2). Make sure that the safe door is open when you start programming the dual code (ON - master code - ENTER).

Step	Action	Key	Signal
1.	Press ON	ON	 
2.	Press Enter	Enter	 
3.	Press 7	7	 
4.	Press ENTER	Enter	 
5.	Key in the master code, e.g. 567891	567891	 
6.	Press Enter	Enter	 

The double code function is now activated.

4.2 Opening with dual code

The lock opens now after entering the master code (ID 0) and the user codes as programmed in chapter 4.1.

Step	Action	Key	Signal
1.	Press ON	ON	 
2.	Key in user ID, e.g. 1	1	 
3.	Press Enter	Enter	 
4.	Key in user code corresponding to user ID 1, e.g. 111111	111111	 
5.	Press Enter	Enter	 
6.	Key in user ID, e.g. 2	2	 
7.	Press Enter	Enter	 
8.	Key in within 1 minute user code corresponding to user ID 2, e.g. 222222.	222222	 
9.	Press Enter	Enter	 

Open the handle within 5 seconds, the safe is open.



User manual electronic lock

4.3 Deactivating dual code

Step	Action	Key	Signal
1.	Press ON	ON	
2.	Press Enter	Enter	
3.	Press 8	8	
4.	Press Enter	Enter	
5.	Key in the master code, for example 567891	567891	
6.	Press ENTER	Enter	

The double code function is now deactivated.



User manual electronic lock

5. Power supply

5.1 Changing the battery

As soon as the battery is almost empty (and the voltage becomes too low), the red light will flash 5 times and a warning signal will sound several times when the door is opened. This is the warning that you need to change the battery.

Do not use rechargeable batteries, only high quality 9-volt batteries.

Unscrew the battery cover on the inside of the door. Remove the battery, insert a new battery, and fit the cover in place again. Then test opening and closing a few times with the door open.

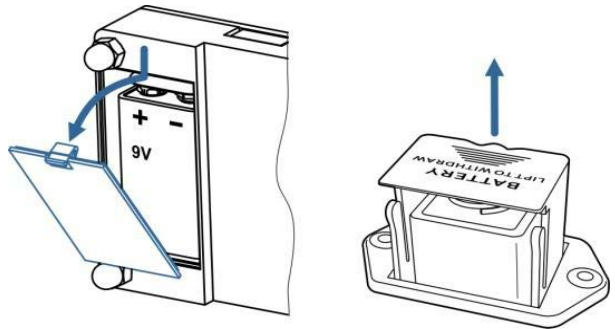

5.2 Emergency power supply

There is an emergency power supply facility on the keyboard, in case the fitted battery becomes completely discharged. Remove the plastic cover plate with a screwdriver. While holding a 9-volt block battery firmly against the '+' and '-', carry out the normal opening procedure. Then you can replace the empty battery.

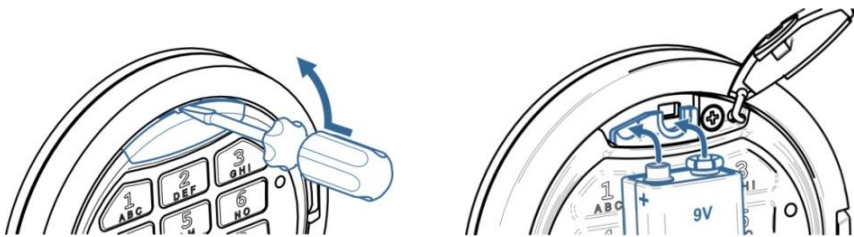

Do you have questions about your safe, the electronic lock or is there an unexpected malfunction?
Please contact us for further assistance.



Bedienungsanleitung Elektronikschloss

1. Allgemein

1.1 Code Eingabe

Das Elektronikschloss arbeitet mit einem 6-stelligen oder 8-stelligen Code. Jede Eingabe wird durch einen Piepton bestätigt und das grüne Licht leuchtet auf.

Nach Eingabe eines gültigen Codes, hören Sie zwei kurze Signale und das grüne Licht blinkt 2 mal kurz auf. Wenn der Code ungültig ist, hören Sie ein langes Signal und das rote Licht leuchtet auf.

1.2 Tresor öffnen

Wenn Sie den Tresor zum ersten Mal benutzen, öffnen Sie das Schloss mit dem Werkscode (ON - Werkscode 123456 - ENTER)

Das Schloss arbeitet mit einem Master-Code und einem Benutzer-Code.

Nach Eingabe des Codes entsperren Sie die Tür innerhalb von 5 Sekunden, indem Sie den Griff benutzen. Wenn Sie das Schloss nicht innerhalb von 5 Sekunden öffnen, verschließt das Schloss die Tür automatisch wieder.

1.3 Tresor schließen



Schließen Sie die Tür und drehen Sie den Griff in die geschlossene Position. Das Schloss ist jetzt automatisch verriegelt. Sie können testen, ob das Schloss gesperrt ist, indem Sie den Griff in die geöffnete Position drehen.

1.4 Sperrung

Die Tastatur wird automatisch für die Dauer von 5 Minuten gesperrt, wenn dreimal hintereinander fehlerhafte Codes eingegeben wurden. In dieser Zeit blinkt die rote Lampe alle paar Sekunden auf. Wenn Sie nach Ablauf der Sperrzeit erneut zweimal einen fehlerhaften Code eingeben, folgt eine Wartezeit von fünf Minuten

1.5 Sicherheitsratschläge

Tauschen Sie bei der Ingebrauchnahme des Schlosses den Standard-Fabrikcode gegen Ihren eigenen persönlichen Zugangscode ein. Vermeiden Sie bei der Wahl Ihres Codes naheliegende Kombinationen, wie z.B. Ihr Geburtsdatum, einen Teil Ihrer Telefonnummer oder Ihre PLZ. Prägen Sie sich den Code ein, und behalten Sie ihn für sich. Wenn Sie ihn dennoch aufschreiben wollen, verwahren Sie ihn an einem sicheren Ort.

Symbole	Bedeutung
	Grüne Lampe leuchtet
	Tonsignal
	Rote Lampe leuchtet





















Bedienungsanleitung Elektronischschloss

2. Master- und Benutzercode

2.1 Mastercode ändern

Achten Sie darauf, dass die Tresortür geöffnet ist, wenn Sie den Code ändern. Tasten Sie ON, geben Sie den Mastercode ein (oder Werkscode 123456 bei der ersten Benutzung), ENTER.

Stufe	Aktion	Taste	Signal
1.	Taste ON	ON	 
2.	Taste Enter	Enter	 
3.	Taste 1	1	 
4.	Taste Enter	Enter	 
5.	Geben Sie den Mastercode ein (oder Werkscode 123456 bei der ersten Benutzung)	123456	 
6.	Taste Enter	Enter	 
7.	Geben Sie den neuen Mastercode ein, z.B. 567891	567891	 
8.	Taste Enter	Enter	 
9.	Geben Sie den neuen Mastercode ein, z.B. 567891	567891	 
10.	Taste Enter	Enter	 

Der neue Mastercode ist jetzt eingestellt. Wird der neue Code nicht akzeptiert, ertönt ein langes Signal und die rote Lampe blinkt. Beginnen Sie dann erneut bei Schritt 1 zur Änderung des Mastercodes. Nach Änderung des Codes sollten Sie den neuen Code am besten mehrmals bei geöffneter Tür testen.



Bedienungsanleitung Elektronischschloss

2.2 Benutzercode einstellen

Der Benutzercode kann nur dann eingestellt werden, wenn der Mastercode zuvor vom Werkscode in einen persönlichen Code geändert wurde. Achtung: Der Benutzercode darf nicht mit dem Mastercode identisch sein! Achten Sie darauf, dass die Tresortür geöffnet ist, wenn Sie den Code ändern (ON – Mastercode – ENTER).

Es können bis zu 9 Benutzer angelegt werden. Diese erhalten die ID 1 bis 9. Zum Beispiel, Benutzer 1 erhält den Code ID "1".

Stufe	Aktion	Taste	Signal
1.	Taste ON	ON	 
2.	Taste Enter	Enter	 
3.	Taste 2	2	 
4.	Taste Enter	Enter	 
5.	Geben Sie den Benutzer ID ein (wählen Sie zwischen 1 - 9) z.B. 1	1	 
6.	Taste Enter	Enter	 
7.	Geben Sie den Mastercode ein, z.B. 567891	567891	 
8.	Taste Enter	Enter	   
9.	Geben Sie den neuen Benutzercode ein, z.B. 111111	111111	 
10.	Taste Enter	Enter	   
11.	Geben Sie den neuen Benutzercode erneut ein, z.B. 111111	111111	 
12.	Taste Enter	Enter	   

Der neue Benutzercode ist jetzt eingestellt. Wird der neue Code nicht akzeptiert, ertönt ein langes Signal und die rote Lampe blinkt. Beginnen Sie dann erneut bei Schritt 1 zur Änderung des Benutzercodes. Nach Einstellung des Codes sollten Sie den neuen Code am besten mehrmals bei geöffneter Tür testen.



Bedienungsanleitung Elektronenschloss

2.3 Benutzercode ändern (durch Benutzer, ohne Mastercode)

Achtung: Der Benutzercode darf nicht mit dem Mastercode identisch sein!

Achten Sie darauf, dass die Tresortür geöffnet ist, wenn Sie den Code ändern (ON – Benutzercode – ENTER).

Es können bis zu 9 Benutzer angelegt werden. Diese erhalten die ID 1 bis 9. Zum Beispiel, Benutzer 1 erhält den Code ID "1".

Stufe	Aktion	Taste	Signal
1.	Taste ON	ON	 
2.	Taste Enter	Enter	 
3.	Taste 3	3	 
4.	Taste Enter	Enter	 
5.	Geben Sie den Benutzer ID ein (wählen Sie zwischen 1 - 9) z.B. 1	1	 
6.	Taste Enter	Enter	 
7.	Geben Sie den Benutzercode ein, z. B. 111111	111111	 
8.	Taste Enter	Enter	   
9.	Geben Sie den neuen Benutzercode ein, z. B. 222222	222222	 
10.	Taste Enter	Enter	   
11.	Geben Sie den neuen Benutzercode erneut ein, z. B. 222222	222222	 
12.	Taste Enter	Enter	   









Der neue Benutzercode ist jetzt eingestellt. Wird der neue Code nicht akzeptiert, ertönt ein langes Signal und die rote Lampe blinkt. Beginnen Sie dann erneut bei Schritt 1 zur Änderung des Benutzercodes. Nach Änderung des Codes sollten Sie den neuen Code am besten mehrmals bei geöffneter Tür testen.



Bedienungsanleitung Elektronischschloss

2.4 Einer Benutzercode löschen

Der Benutzercode kann nur nach Eingabe des Mastercodes gelöscht werden.

Stufe	Aktion	Taste	Signal
1.	Taste ON	ON	 
2.	Taste Enter	Enter	 
3.	Taste 0	0	 
4.	Taste Enter	Enter	 
5.	Geben Sie den Benutzer ID ein (wählen Sie zwischen 1 - 9) z.B. 1	1	 
6.	Taste Enter	Enter	 
7.	Geben Sie den Mastercode ein, z.B. 567891	567891	 
8.	Taste Enter	Enter	   

War die Löschung des Benutzers nicht erfolgreich, ertönt ein langer Signalton. Beginnen Sie dann erneut bei Schritt 1, um den Benutzercode zu löschen.



Bedienungsanleitung Elektronischschloss

3. Öffnungsverzögerung und Öffnungsfenster

Öffnungsverzögerung 1-99 Minuten:
Die Wartezeit bis Sie das Schloss öffnen können.

Öffnungsfenster 1-9 Minuten:
In diesem Fenster müssen Sie den Code erneut eingeben, um den Safe zu öffnen.

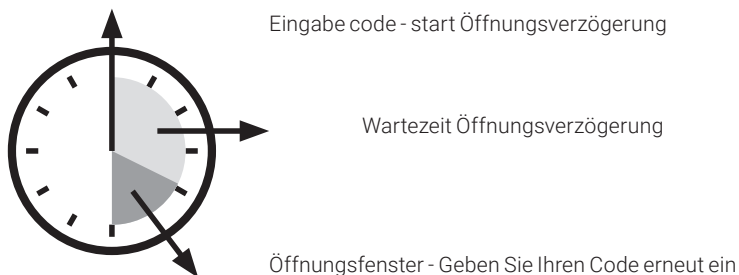

3.1 Programmierung der Öffnungsverzögerung und des Öffnungsfensters

Eine Öffnungsverzögerung und ein Öffnungsfenster können nur nach Eingabe des Mastercodes programmiert werden. Achten Sie darauf, dass die Tresortür geöffnet ist, wenn Sie eine Öffnungsverzögerung und ein Öffnungsfenster programmieren (ON – Mastercode – ENTER).

















Stufe	Aktion	Taste	Signal
1.	Taste ON	ON	● 🔊
2.	Taste Enter	Enter	● 🔊
3.	Taste 6	6	● 🔊
4.	Taste Enter	Enter	● 🔊
5.	Geben Sie den Mastercode ein, z.B. 567891	567891	● 🔊
6.	Taste Enter	Enter	● ● 🔊 🔊
7.	Taste Öffnungsverzögerung mit 2 Zahlen, z.B. 5 Minuten	05	● 🔊
8.	Taste Öffnungsverzögerung mit 1 Zahlen, z.B. 1 Minuut	1	● 🔊
9.	Taste Enter	Enter	● ● 🔊 🔊

Die Öffnungsverzögerung und das Öffnungsfenster sind jetzt eingestellt.



Bedienungsanleitung Elektronischschloss

3.2 Öffnen mit Öffnungsverzögerung und Öffnungsfenster

Stufe	Aktion	Taste	Signal
1.	Taste ON	ON	 
2.	Taste Benutzer- oder Mastercode ein, z.B. 567891	567891	 
3.	Taste Enter	Enter	 
4.	Öffnungsverzögerungszeit beginnt, rote Lampe leuchtet alle 5 Sekunden auf		
5.	Wenn die Öffnungsverzögerungszeit abgelaufen ist, ertönt ein Signalton		
6.	Öffnungsfensterzeit beginnt, es ertönt ein Signalton und die rote Lampe leuchtet alle 5 Sekunden auf		 
7.	Taste Benutzer- oder Mastercode ein, z.B. 567891	567891	 
8.	Taste Enter	Enter	   
9.	Öffnen Sie den Griff innerhalb von 5 Sekunden, der Safe ist offen.		

3.3 Öffnungsverzögerung deaktivieren

Öffnen Sie das Schloss. Folgen Sie hierzu die Schritte aus Abschnitt 3.2.

Stufe	Aktion	Taste	Signal
1.	Taste ON	ON	 
2.	Taste Enter	Enter	 
3.	Taste 6	6	 
4.	Taste Enter	Enter	 
5.	Geben Sie den Mastercode ein, z.B. 567891	567891	 
6.	Taste Enter	Enter	   
7.	Taste 000	000	
8.	Taste Enter	Enter	   

Die Öffnungsverzögerung und das Öffnungsfenster sind jetzt deaktiviert.

















Bedienungsanleitung Elektronikschloss

3.4 Öffnungsverzögerung bzw. Öffnungsfenster ändern

Deaktivieren Sie zunächst die eingestellte Öffnungsverzögerung und das Öffnungsfenster (siehe Abschnitt 3.3). Befolgen Sie danach die Schritte aus Abschnitt 3.2, um eine neue Öffnungsverzögerung und ein neues Öffnungsfenster einzustellen.

3.5 Signalton für Öffnungsfenster aktivieren/deaktivieren

Der Signalton kann nur nach Eingabe des Mastercodes aktiviert bzw. deaktiviert werden.

Stufe	Aktion	Taste	Signal
1.	Taste ON	ON	 
2.	Taste Enter	Enter	 
3.	Taste 5	5	 
4.	Taste Enter	Enter	 
5.	Geben Sie den Mastercode ein, z.B. 567891	567891	 
6.	Taste Enter	Enter	   



Bedienungsanleitung Elektronikschloss

4. Dualer Code (4-Augen-Prinzip)

4.1 Programmierung dualer Code

Stellen Sie sicher, dass mindestens ein Benutzer-Code programmiert wurde (siehe 2.2). Stellen Sie sicher, dass die Safetür offen steht, wenn Sie die Programmierung des dualen Codes (ON - Master Code - ENTER) beginnen.

Stufe	Aktion	Taste	Signal
1.	Taste ON	ON	
2.	Taste Enter	Enter	
3.	Taste 7	7	
4.	Taste Enter	Enter	
5.	Geben Sie den Mastercode ein, z.B. 567891	567891	
6.	Taste ENTER	Enter	

Die Funktion dualer Code ist jetzt aktiviert

4.2 Öffnen mit dualem Code

Das Schloss öffnet sich jetzt nach Eingabe der Mastercode (ID 0) und der Benutzer-Codes, wie in Kapitel 4.1 programmiert.

Stufe	Aktion	Taste	Signal
1.	Taste ON	ON	
2.	Geben Sie den Benutzer-ID ein, z.B. 1	1	
3.	Taste ENTER	Enter	
4.	Geben Sie den Benutzer-Code ein, welche mit der Benutzer-ID 1 korrespondiert, z.B. 111111	111111	
5.	Taste Enter	Enter	
6.	Geben Sie den Benutzer-ID ein, z.B. 2	2	
7.	Taste Enter	Enter	
8.	Erfassen Sie innerhalb von 1 Minute den Benutzer-Code, der mit Benutzer-ID 2 korrespondiert, z.B. 222222.	222222	
9.	Taste Enter	Enter	

Öffnen Sie die Griff innerhalb von 5 Sekunden, der Safe ist dann offen.



Bedienungsanleitung Elektronischschloss

4.3 Deaktivierung dualer Code

Stufe	Aktion	Taste	Signal
1.	Taste ON	ON	
2.	Taste Enter	Enter	
3.	Taste 8	8	
4.	Taste Enter	Enter	
5.	Geben Sie den Mastercode ein, z.B. 567891	567891	
6.	Taste Enter	Enter	

Die Doppelfunktion ist jetzt deaktiviert



Bedienungsanleitung Elektronikschloss

4. Stromversorgung

4.1 Batteriewechsel

Sobald die Batterie leer ist (und die Spannung zu niedrig wird), wird die rote Lampe fünfmal blinken und beim Öffnen der Tür ertönt mehrmals ein Warnsignal. Dies ist das Zeichen dafür, dass die Batterie gewechselt werden muss.

Verwenden Sie keine aufladbaren Batterien, sondern ausschließlich hochwertige 9V-Batterien. Lockern Sie die Schraube des Batteriedeckels an der Innenseite der Tür. Nehmen Sie die Batterie heraus, legen Sie eine neue Batterie ein und schrauben Sie den Deckel daraufhin wieder fest. Testen Sie anschließend das Öffnen und Schließen einige Male bei geöffneter Tür.

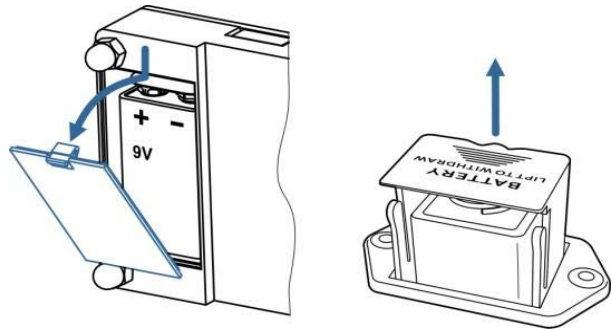

4.2 Notstromversorgung

Auf der Tastatur befindet sich die Notstromversorgung für den Fall, dass sich die eingelegte Batterie völlig entladen hat. Entfernen Sie die Plastikabdeckung mit einem Schraubendreher. Während Sie eine 9V-Blockbatterie fest an den Plus- und den Minuspol halten, befolgen Sie das normale Verfahren zur Öffnung des Tresors. Danach können Sie die leere Batterie wechseln.

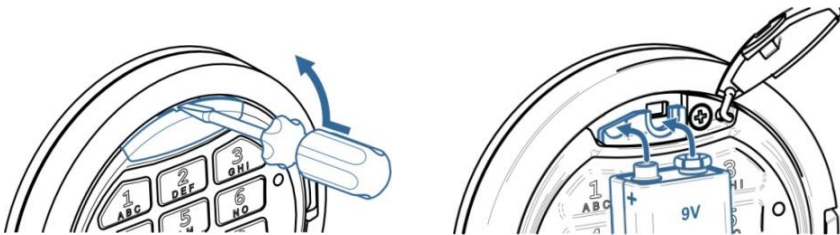

Haben Sie Fragen zu Ihrem Tresor, Elektronikschloss oder ist ein Fehler aufgetreten?
Bitte kontaktieren Sie uns.



SafetyFirst[®]

