

Key Lock

- GB Quick user guide
- FR Mini-guide de l'utilisateur
- DE Kurzanleitung
- NL Beknopte handleiding
- IT Guida veloce
- ES Guía rápida de usuario
- PT Guia rápido do Utilizador
- PL Krótki podręcznik użytkownika
- RU Краткое руководство пользователя
- SE Snabb bruksanvisning
- NO Hurtigguide
- DK Hurtig brugervejledning
- FI Pikaopas
- ID Panduan cepat untuk pengguna
- CN 便捷用户指南
دليل الاسترخ دام السري ع

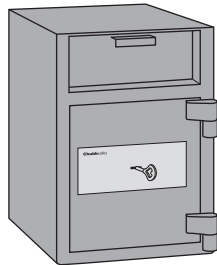

M10

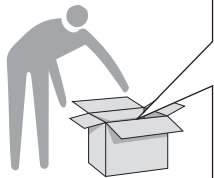
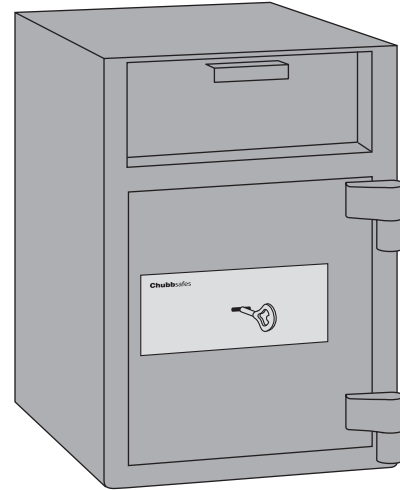
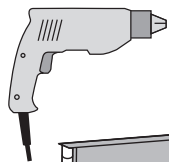
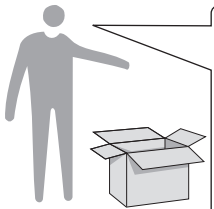
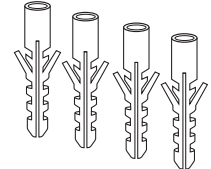
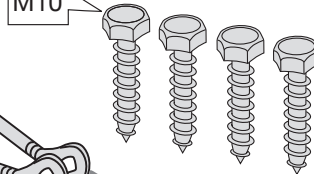
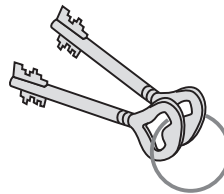

12 mm

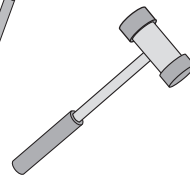

17 mm



Chubbsafes

Trusted the world over.

<http://www.chubbsafes.com>

'Chubb' is owned by Chubb plc and is a registered trademark used under license

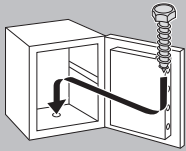

GB The safe must be anchored when in use.
 FR Le coffre doit être ancré.
 DE Wenn der Safe verwendet wird, muss er verankert sein.
 NL De kluis moet tijdens gebruik verankerd zijn.
 IT La cassaforte deve essere fissata durante l'uso.
 ES La caja debe anclarse al usarla.
 PT O cofre tem de encontrar-se fixado quando em utilização.
 PL Sejf jeżeli jest używany musi być zamocowany.

RU Сейф должен быть укреплен перед использованием.
 SE Kassaskåpet måste vara förankrat när det används.
 NO Safen må være forankret når den er i bruk.
 DK Pengeskabet skal være fastgjort, når det er i brug.
 FI Kassakaapin on oltava käytön aikana kiinnitettyinä.
 ID Pengaman harus ditanamkan pada saat digunakan.
 CN 使用中的保险柜必须固定在某个位置。
 يجب أن تكون الخزنة ثابتة أثناء الاستخدام.

1

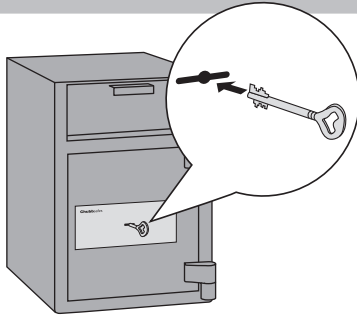

2

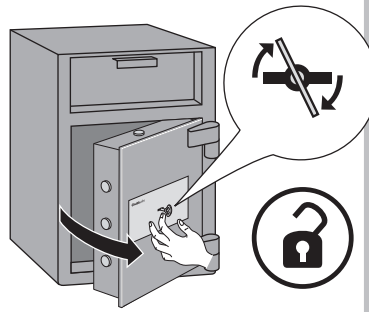

3

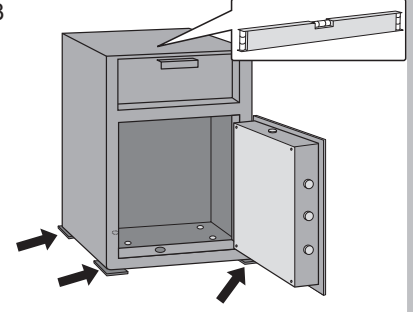

4

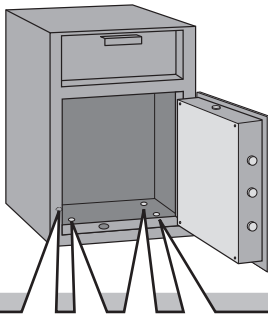

a)

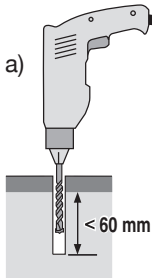

b)

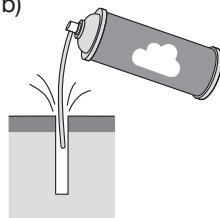

c)

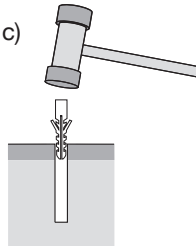

d)

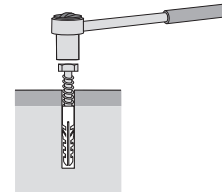

5

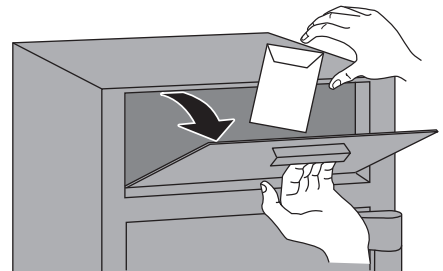
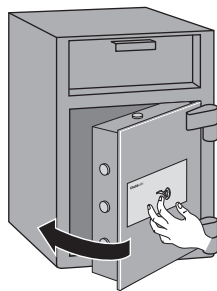

Chubbsafes
 Trusted the world over.

<http://www.chubbsafes.com>

'Chubb' is owned by Chubb plc and is a registered trademark used under license